



KEIFIAT MADARAN ARMAN NOVIN (KAMAN)

ENGINEERING &
KNOWLEDGE-BASED COMPANY

KAMAN COMMERCIAL EMI FILTER Part Number: KF-CWA-6S



Features and Benefits

- Significant attenuation of CM/DM noise in different frequency ranges
- The proper arrangement of components results in an efficient, compact, lightweight and cost-effective filter.
- Comes with a one-year warranty

Product Identification

KF-CWA-6S

- **KF:** Kaman Filter
- **C:** Commercial Products Without Standards
- **W:** Low (L), High (H) or Wideband (W) cutoff freq.
- **A:** Product Performance (A: Excellent, B: Good, C: Average, D: Poor)
- **6:** Rated current (1,3,6,8,10,16,20,30,45,60)
- **S:** Terminal type (Stud type (S), Phoenix type (F), Power type (P), Rail type (R))

Technical specification

Phase	Single (S)
Rated Voltage	250VAC
Rated Current	6A
Operating Frequency	50/60Hz
Attenuated Frequency Range	0.1 to 30MHz
Leakage Current	0.6 mA
Operating Temperature	-10 to +70 .C
Weight	560 gr
I/O Connection	Stud type (S)

Attenuation Characteristics

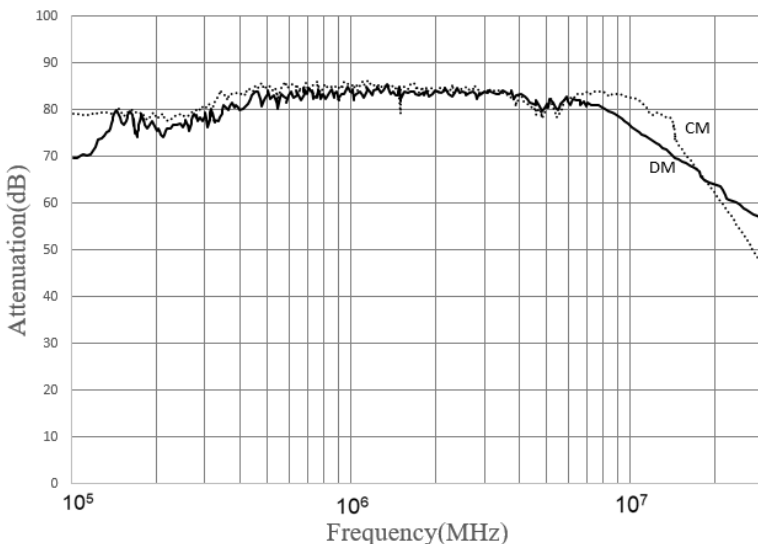

Mechanical Data

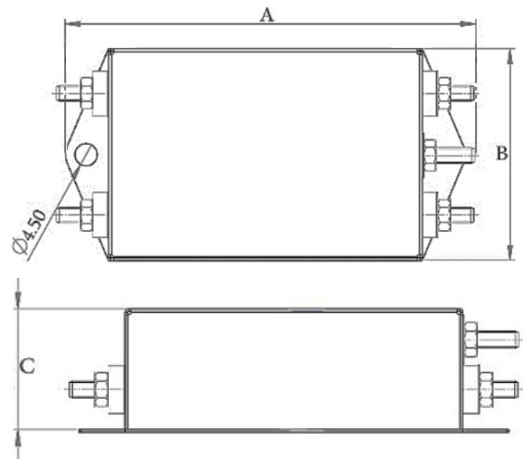

Part Number:	C	B	A
KF-CWA-6S	40	70	110