



KEFIAT MADARAN ARMAN NOVIN (KAMAN)

ENGINEERING &
KNOWLEDGE-BASED COMPANY

KAMAN COMMERCIAL EMI FILTER Part Number: KF-CT3A-10S



Features and Benefits

- Significant attenuation of CM/DM noise in different frequency ranges
- The proper arrangement of components results in an efficient, compact, lightweight and cost-effective filter.
- Comes with a one-year warranty

Product Identification

KF-CT3A-10S

- **KF:** Kaman Filter
- **C:** Commercial Products Without Standards
- **T:** Three phase products
- **3:** Number of Lines (3,4: With Null)
- **A:** Product Performance (A: Excellent, B: Good, C: Average, D: Poor)
- **10:** Rated current (1,3,6,8,10,16,20,30,45,60)
- **S:** Terminal type (Stud type (S), Phoenix type (F), Power type (P), Rail type (R))

Attenuation Characteristics

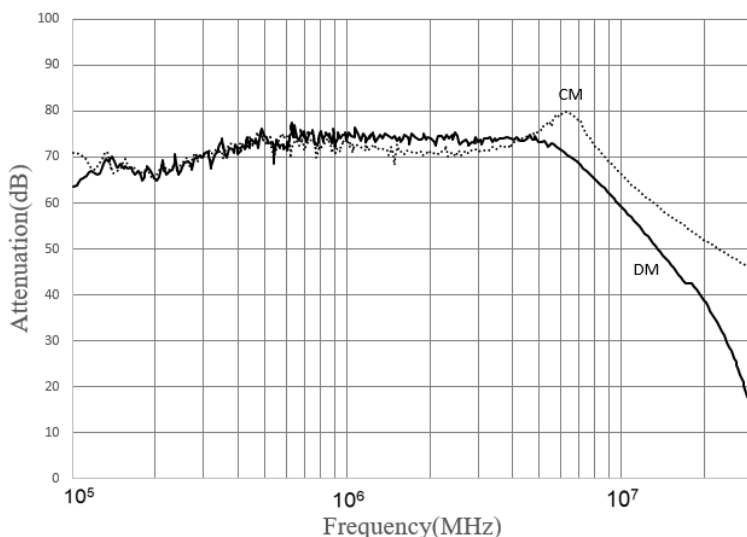

Technical specification

Phase	Three (T)
Rated Voltage	380VAC
Rated Current	10A
Operating Frequency	50/60Hz
Attenuated Frequency Range	0.1 to 30MHz
Leakage Current	1.2 mA
Operating Temperature	-10 to +70 .C
Weight	1550 gr
I/O Connection	Stud type (S)

Mechanical Data

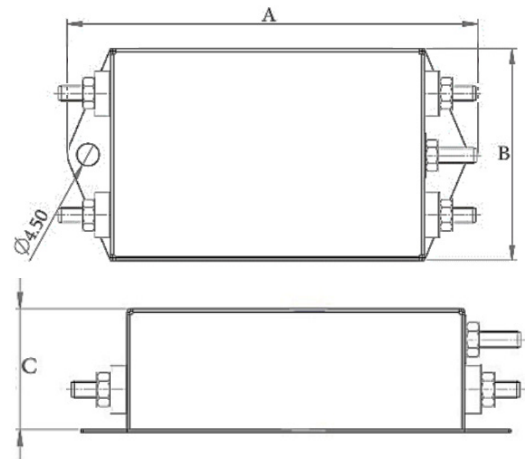

Part Number:	C	B	A
KF-CT3A-10S	50	90	140